

Envoy™ Employee Locker

All-welded painted steel locker, welded hasp assembly.

MATERIAL: Cold rolled steel; Bottom shelf galvanized.

- Frame: 16 GA.
- Doors: 20 GA.
- Hasp: 11 GA.
- Hinge: 14 GA.

Magnetic strip door closure.

Full length handle grasp.







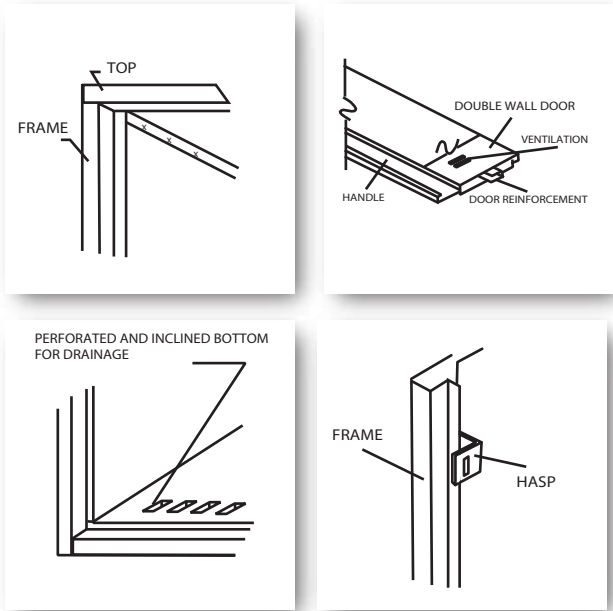
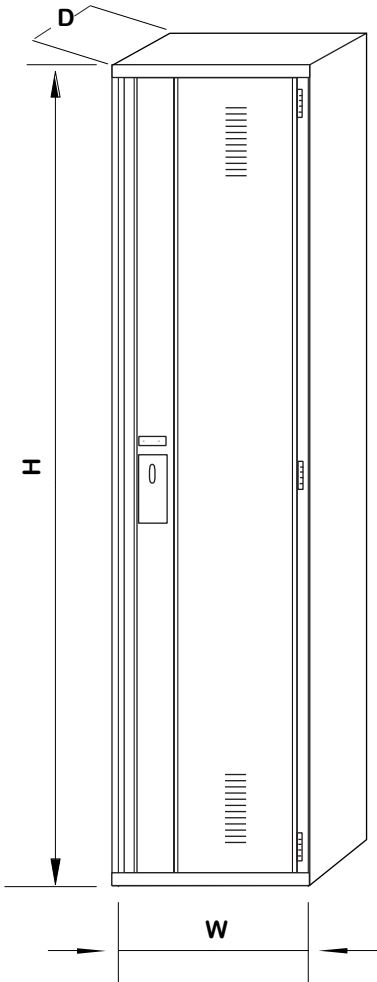

Front louver ventilation.

FINISH: Baked enamel, Standard Colors: beige, grey, black. Optional Colors: corn, medium blue, warm beige, blue, mist grey, medium green, charcoal grey, light green, grey blue, marine blue, cadet blue, dresden blue, sandalwood, burgundy, dark green, white.

OPTIONS:

- 1 Tier Model: Hat shelf, coat hooks.
- 2 Tier Model: Coat hooks.
- All Tier Models: Sloping tops, 4" bases.



Envoy™	Available Configurations					
Tiers						
	One Tier	Two Tier	Three Tier	Four Tier	Five Tier	Six Tier
Sizes	Height Frames: 72"		Width Frames: 12", 15", 18"		Depth Frames: 15", 18", 21"	
Frames <i>Maximum Assembled Frames per Model:</i>	 15" Width: 2 Frames		 18" Width: 2 Frames		 12" Width: 3 Frames	

Envoy Series

MODEL:	Envoy		
MAT:	CRS Painted		
DWG#:	ENV01	SCALE:	
DATE:	10/22/07	BY:	er